

Article number: 021816011140

Description: Clamp with bracket and rubber  
SPGU 6011. 140/30 SK

## Measures

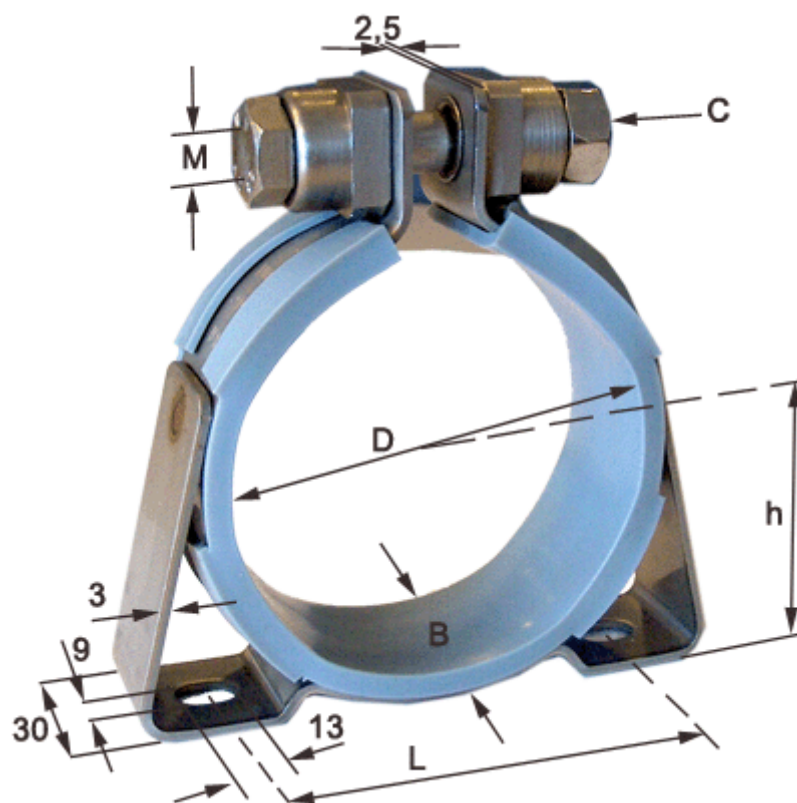

C (screw type) = SK hexagon screw

Diameter D = 140

h = 79

L = 136

Width B = 30